

napomena:
 Separator lakih tekućina (naftnih derivata)
 za parkirališne površine model MONOBLOCK

* opcijski
 produžetak

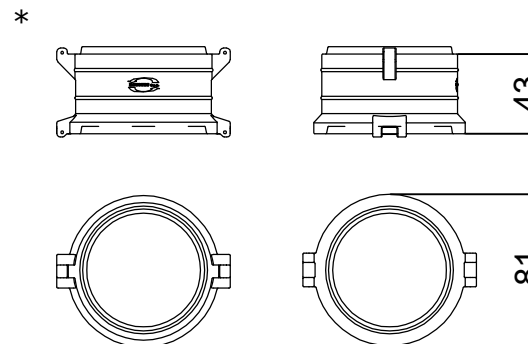
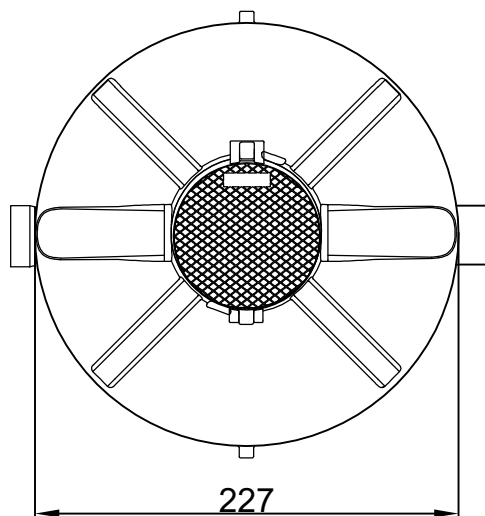
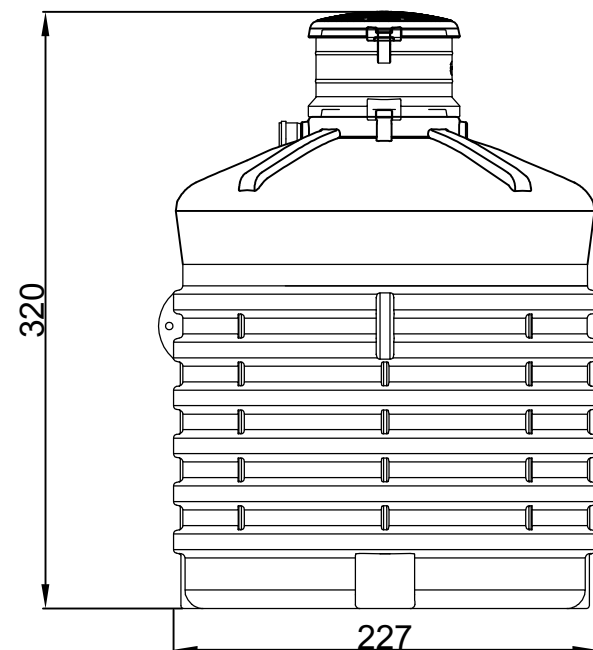
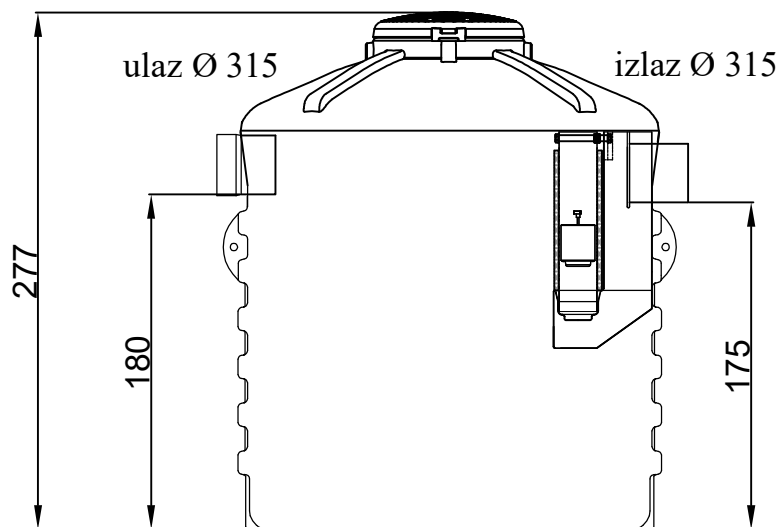

Aquos Eco d.o.o.
www.aquoseco.hr

SEPARATOR LAKIH TEKUĆINA
 MONOBLOCK tip AQ 8000 NPI
 Ø ul/iz 315

Projekt:	0729 NPI KZ	Norma HR/EU:	HRN EN 858-1:2002 HRN EN 858-2:2003	Klasa:	klasa I	MDK:	< 5 mg/l
Datum:		Uredio:		Ukupno stranica:		Sljedeća stranica:	