

ulaz Ø 400

izlaz Ø 400

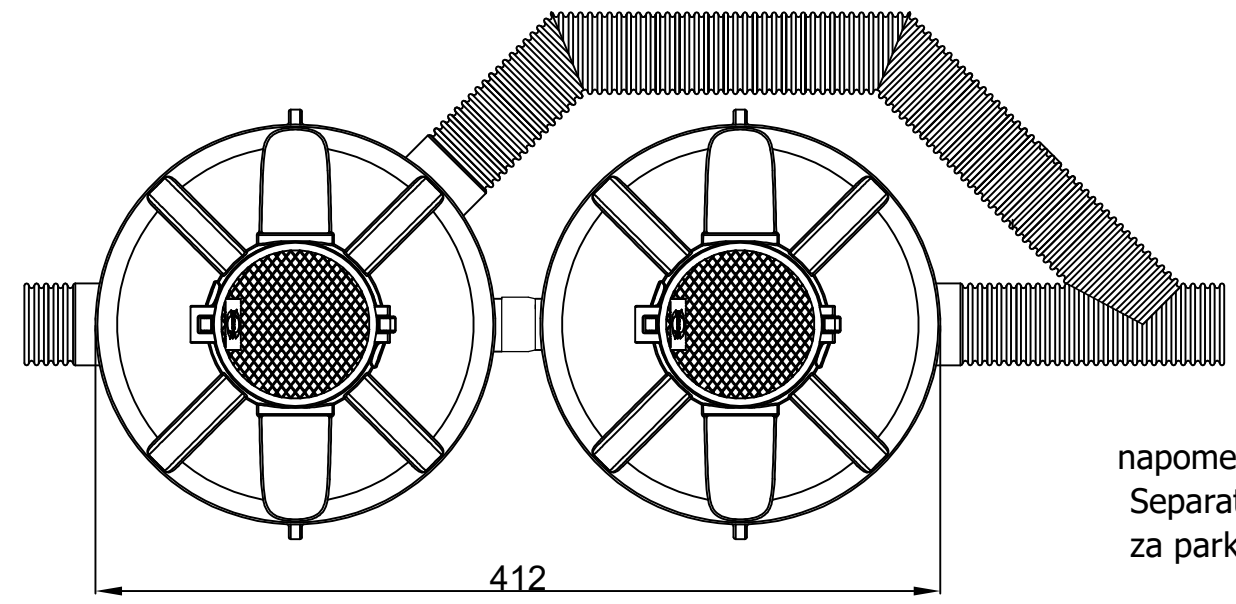

\* opcijski produžetak

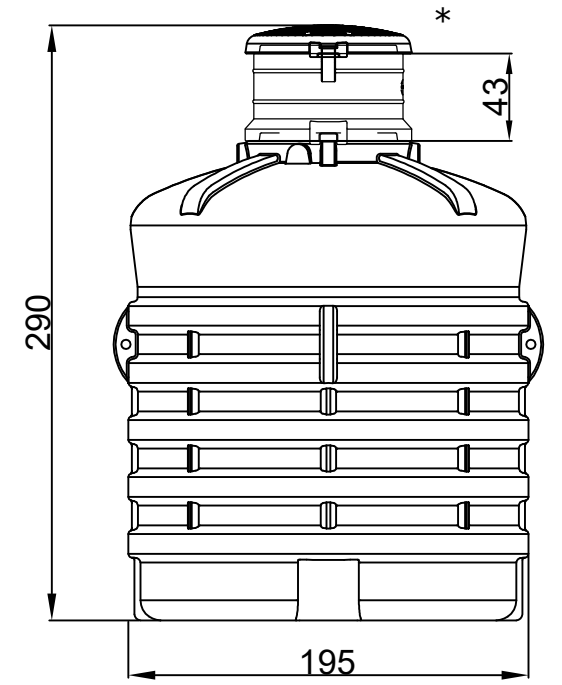
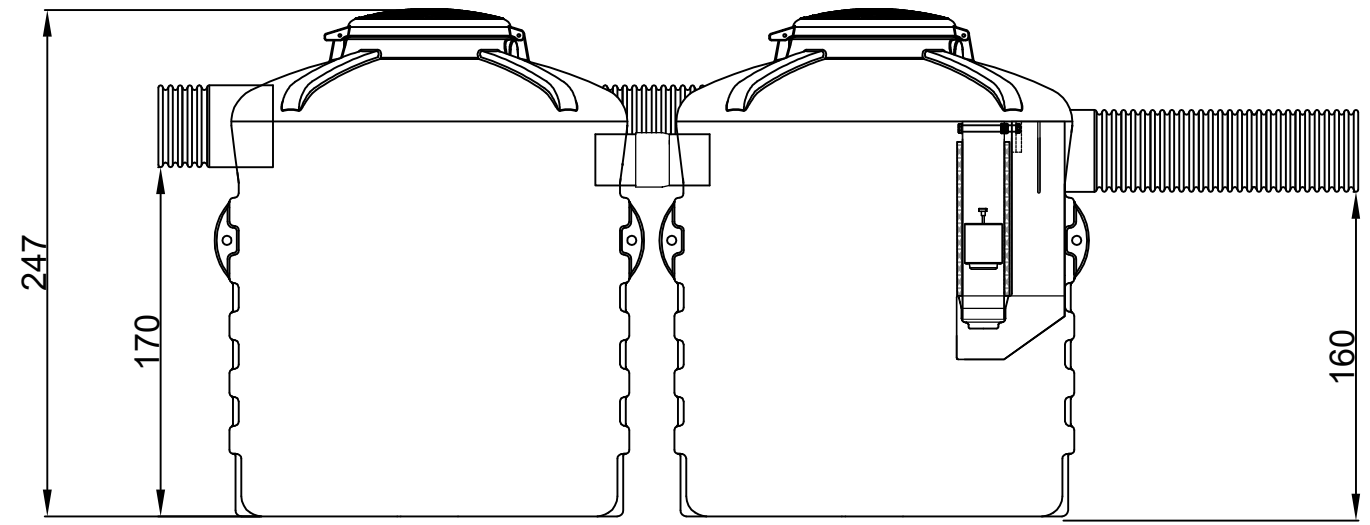
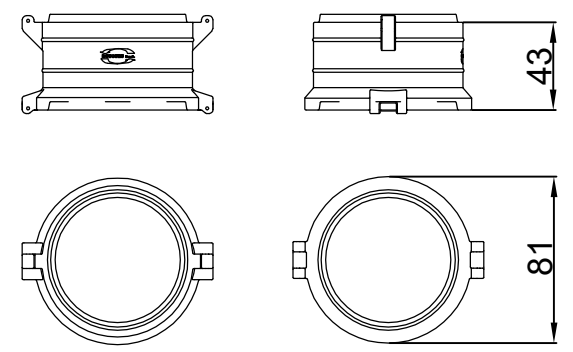

napomena:  
 Separator lakih tekućina (naftnih derivata)  
 za parkirališne površine model DUALBLOCK



Aquos Eco d.o.o.  
[www.aquoseco.hr](http://www.aquoseco.hr)

**SEPARATOR DUALBLOCK**  
 tip AQB 10000 NPI  
 Ø ul/iz 400  
 Q 50/250 l/s

Projekt:  
 0730 NPI KZTB

Norma HR/EU:  
 HRN EN 858-1:2002  
 HRN EN 858-2:2003

Klasa:  
 klasa I

MDK:  
 < 5 mg/l

Datum:

Uredio:

Ukupno stranica:

Sjedeća stranica: