

napomena:
 Separator lakih tekućina (naftnih derivata)
 za parkirališne površine model MONOBLOCK

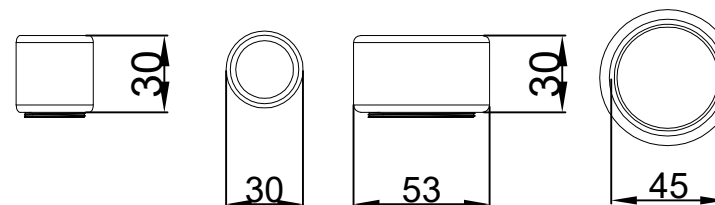

napomena: * opcijski produžetak
 nije u standardnom sastavu uređaja

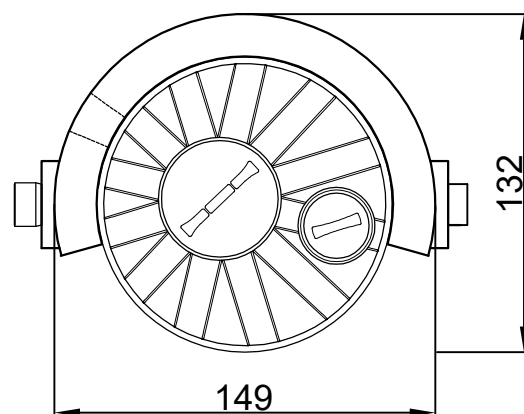
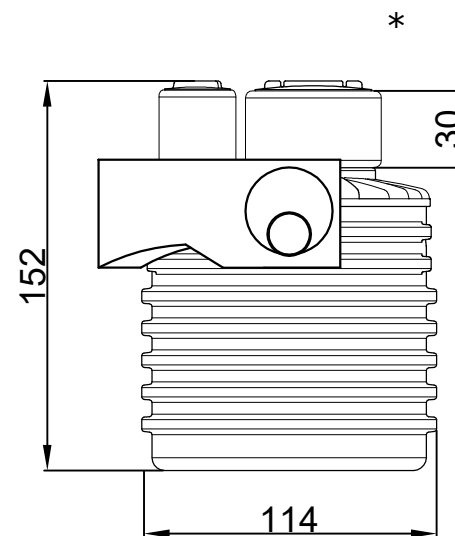
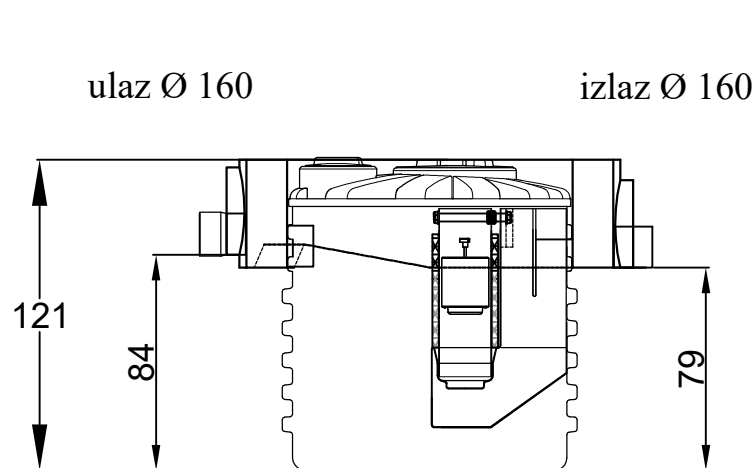

Aquos Eco d.o.o.
www.aquoseco.hr

SEPARATOR MONOBLOCK
 tip AQB 1000 NSE
 Ø ul/iz 160
 Q 3/15 l/s

Projekt: 0722 NSE KZB	Norma HR/EU: HRN EN 858-1:2002 HRN EN 858-2:2003	Klasa: klasa I	MDK: < 5 mg/l
Datum:	Uredio:	Ukupno stranica:	Sljedeća stranica: